

MEASURES

DIMENSIONS H x W x D	625x700x485 mm
GROSS/NET WEIGHT	119/100 kg
FIREWOOD ENTRANCE	550x311 mm
SMOKE FLUE	Ø 150-153 mm Top
EXTERNAL AIR INTAKE	Ø 80 mm

CHARACTERISTICS

CAST IRON GRILL	
PANORAMIC VISION	
STEEL BODY SHEET	5 mm
NOMINAL HEAT OUTPUT	7 KW
EFFICIENCY	81 %
CO EMISSIONS	0,10%
HEAT RESISTANT PAINT	800°C
CERAMIC GLASS HEAT RESISTANCE	750°C

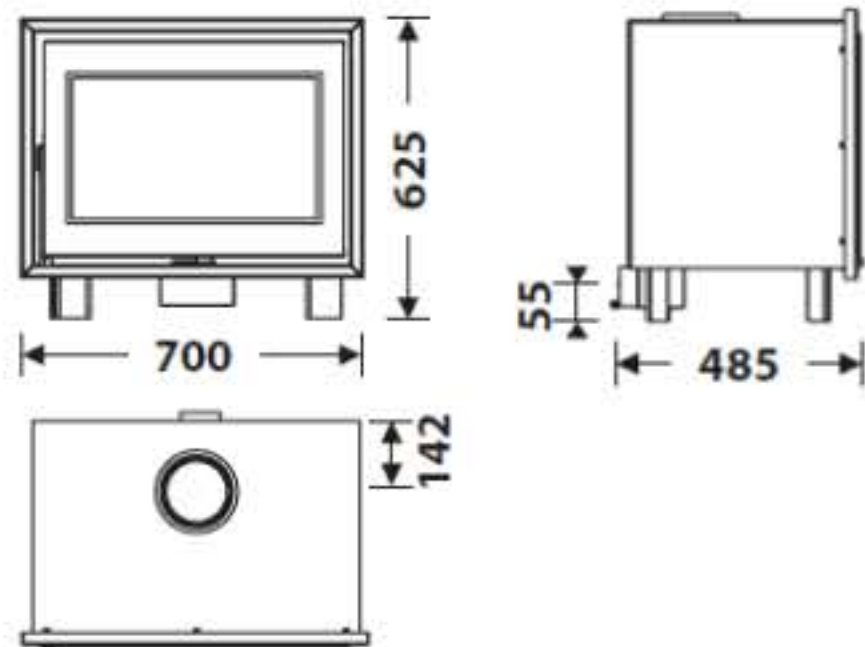

PRODUCT PLUS

ECODESIGN

-  EXTERNAL AIR INTAKE
-  VERMICULITE LINING
-  PRINTED GLASS
-  WOOD LOGS 50 CM
-  220 m³ HEATING VOLUME
-  CLEAN GLASS SYSTEM
-  DOUBLE COMBUSTION



EAN 8426964247008
REF. 24700



BImSchV2



DF-70 EcoDesign

